

LEVEL	FACE WIDTH	PLATFORM
25000	2000	
22500	2000	Working Platform
20000	2000	Working Platform
17500	2000	Working Platform
15000	2000	
12500	2250	
10000	2500	Rest Platform
7500	2750	
5000	3000	
2500	3250	
0000	3500	

LEG JOINT NAME	LEG LENGTH	LEGS SIZE
A	2500	65x65x6
B	2500	75x75x6
C	2500	100x100x10
D	2503	120x120x10
E	2503	130x130x12
F	2503	

PANEL NO	LENGTH(METER)	DIAGONALS	PANEL TOP- HORIZONTALS	PANEL MID- HORIZONTALS	PLAN BRACING	SEC. BRACING
1	2.5	50x50x4	50x50x4	45x45x04	45x45x04	
2	2.5	55x5	50x50x4	45x45x04	45x45x04	
3	2.5	60x60x5	50x50x4	50x50x4	50x50x4	
4	2.5	50x5	50x50x4	50x50x4	50x50x4	
5	2.5	50x5	50x50x4	50x50x4	50x50x4	
6	2.5	50x50x5	50x50x4	50x50x4	50x50x4	
7	2.5	55x55x5	50x50x4	50x50x4	50x50x4	
8	2.5	50x50x5	50x50x4	50x50x4	50x50x4	
9	2.5	55x55x5	50x50x4	50x50x4	50x50x4	
10	2.5	50x50x5	50x50x4	50x50x4	50x50x4	



PLAN VIEWS

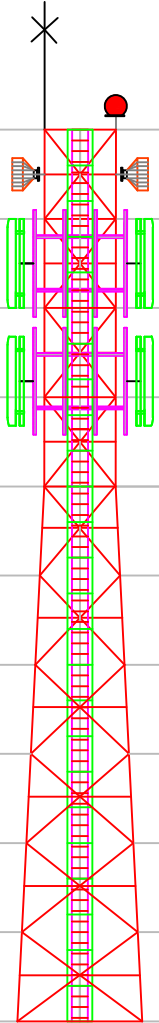

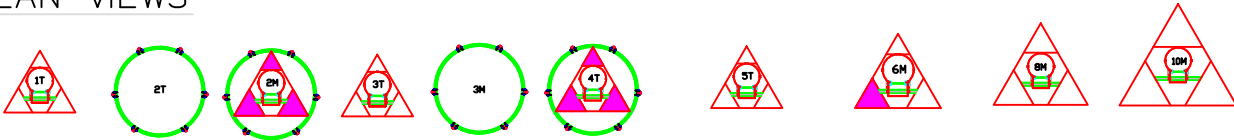
- 1) Remote Radio Head- 6+4nos (Total Weight 270kgs.)
- 2) Sectoral Antennas - 6+4nos (Total Weight 242kgs.)
- 3) Microwave Antennas (0.9m)-2nos (Total Weight 50kgs.)
- 4) Microwave Antennas (1.2m)-2nos (Total Weight 60kgs.)
- 5) Antennas Mounting Structure (Total Weight 270kgs.)

TITLE	25 METER TOWER	Wind Speed	180 KMPH	Design	TIA/EIA-222 G
SUB. TITLE	TRIANGULAR ANGULAR TOWER	Deflection	< 1.0 Degree	Rev.	
Drawing	BT - 2024 Project	Loading	892 kgs.	Drawn Date	08-12-2023
BHUTAN TELECOM LTD.			Tower Weight 4450 kgs.		

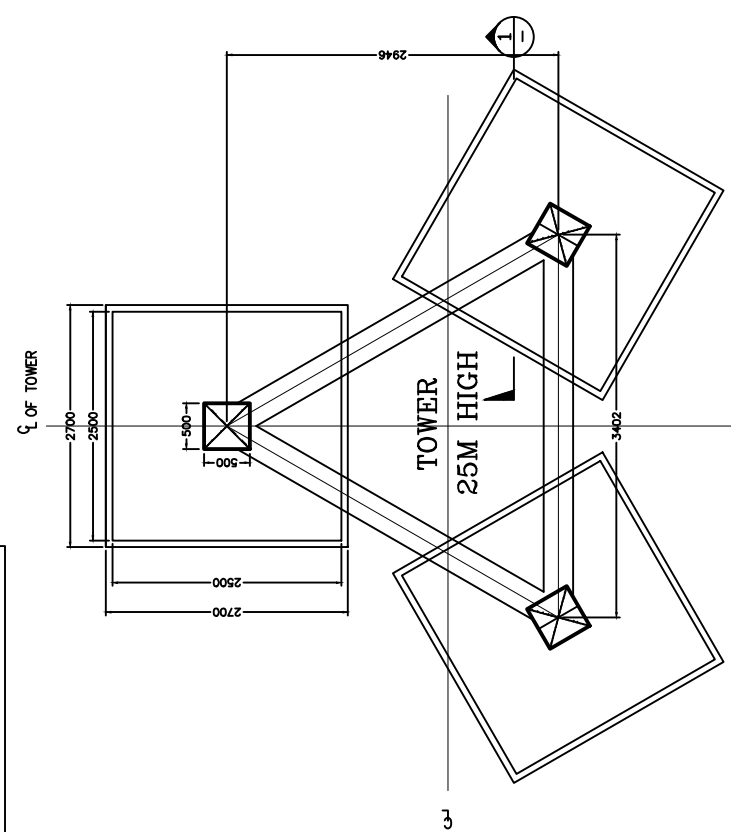

FOUNDATION KEY PLAN

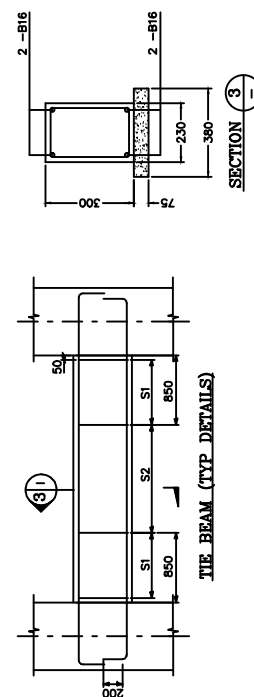

STIRRUP DETAILS  
 S1: -2 LEGGED Y8 @ 100 C/C  
 S2: -2 LEGGED Y8 @ 200 C/C

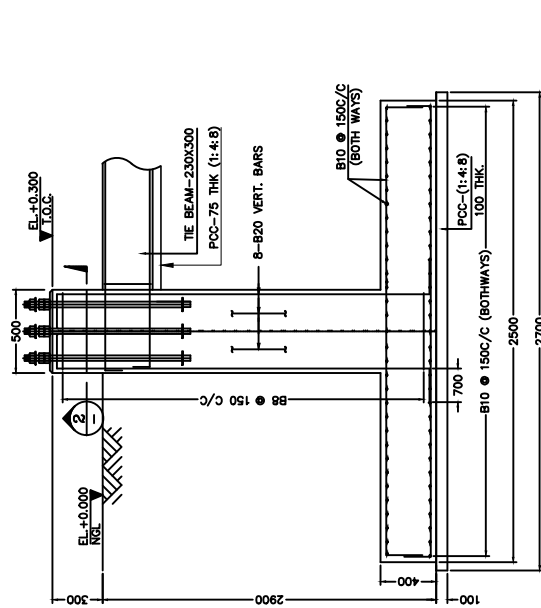

SECTION 1

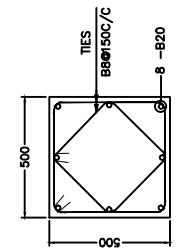

SECTION 2

COLUMN 500X500

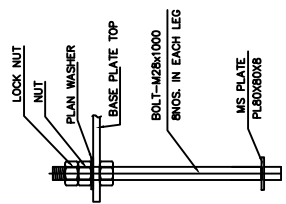

ANCHOR BOLT

- NOTES**
1. ALL DIMENSIONS ARE IN MM UNLESS NOTED OTHERWISE.
  2. USE M20 GRADE CONCRETE AND F4 500 GRADE FOR STEEL.
  3. CLEAR COVER TO MAIN REINFORCEMENT:-  
 (a) 50MM FOR FOUNDATION (b) 25MM FOR BEAMS  
 (c) 40MM FOR COLUMNS
  4. PRIOR TO AND DURING CONCRETING ALL BOLTS SHALL BE SECURELY HELD IN POSITION BY USE OF TEMPLATE.
  5. BEFORE COMMENCEMENT OF CONSTRUCTION USING THIS DESIGN, CLIENT/CONTRACTOR SHALL CARRY OUT DETAILED SOIL INVESTIGATION OF EVERY SITE.
  6. THIS FOUNDATION DESIGN SHALL NOT BE USED IN CASE HIGHLY SOIL ARE FOUND AT ANY DEPTH DURING SOIL INVESTIGATION.
  7. CONCRETE SHALL BE MECHANICALLY MIXED & VIBRATED.
  8. SPACING OF BARS SHALL NOT BE MORE THAN 50% AT ANY LOCATION.
  9. PROPER CURING OF CONCRETE SHALL BE DONE.
  10. BENDING OF BARS SHALL BE AS PER IS:2502.
  11. ANY DISCREPANCY SHOULD BE BROUGHT TO THE CONSULTANT'S ATTENTION.

**GENERAL DETAILS**

S.No	DESCRIPTION	DETAILS
1	SOIL BEARING CAPACITY	10.00 T/SQM
2	DRY DENSITY OF SOIL	1.8 T/SQM
3	ANGLE OF REPOSE	30.00 DEGREE

**BILL OF MATERIALS**

ITEM	UNIT	TOTAL
EXCAVATION	CUM	66.0
PCC-(1:4:8)	CUM	2.45
RCC-M20	CUM	10.2
STEEL-F6500	KG	860

CHAIRS SHALL BE PROVIDED WHEREVER REQUIRED

**BAR BENDING SCHEDULE**

**REVISION NOTES**

REV. NO.	DESCRIPTION	DATE	SIGN.
DRAWN	CHECKED	APPROVED	SCALE
Bhutan Telecom	Bhutan Telecom	Bhutan Telecom	14-12-2023

CLIENT: BHUTAN TELECOM LTD.  
 DESIGN BY: BHUTAN TELECOM LTD.  
 PROJECT: GENERIC ISOLATED FOUNDATION DESIGN  
 BHUTAN  
 TITLE: FOUNDATION DETAILS FOR 25M HIGH TRIANGULAR TOWER  
 SEC: 10 T/SQM  
 DRAWING No. SH. NO. REV.  
 BT-2024 Project

# BARBED WIRE FENCING AND GATE DRAWING

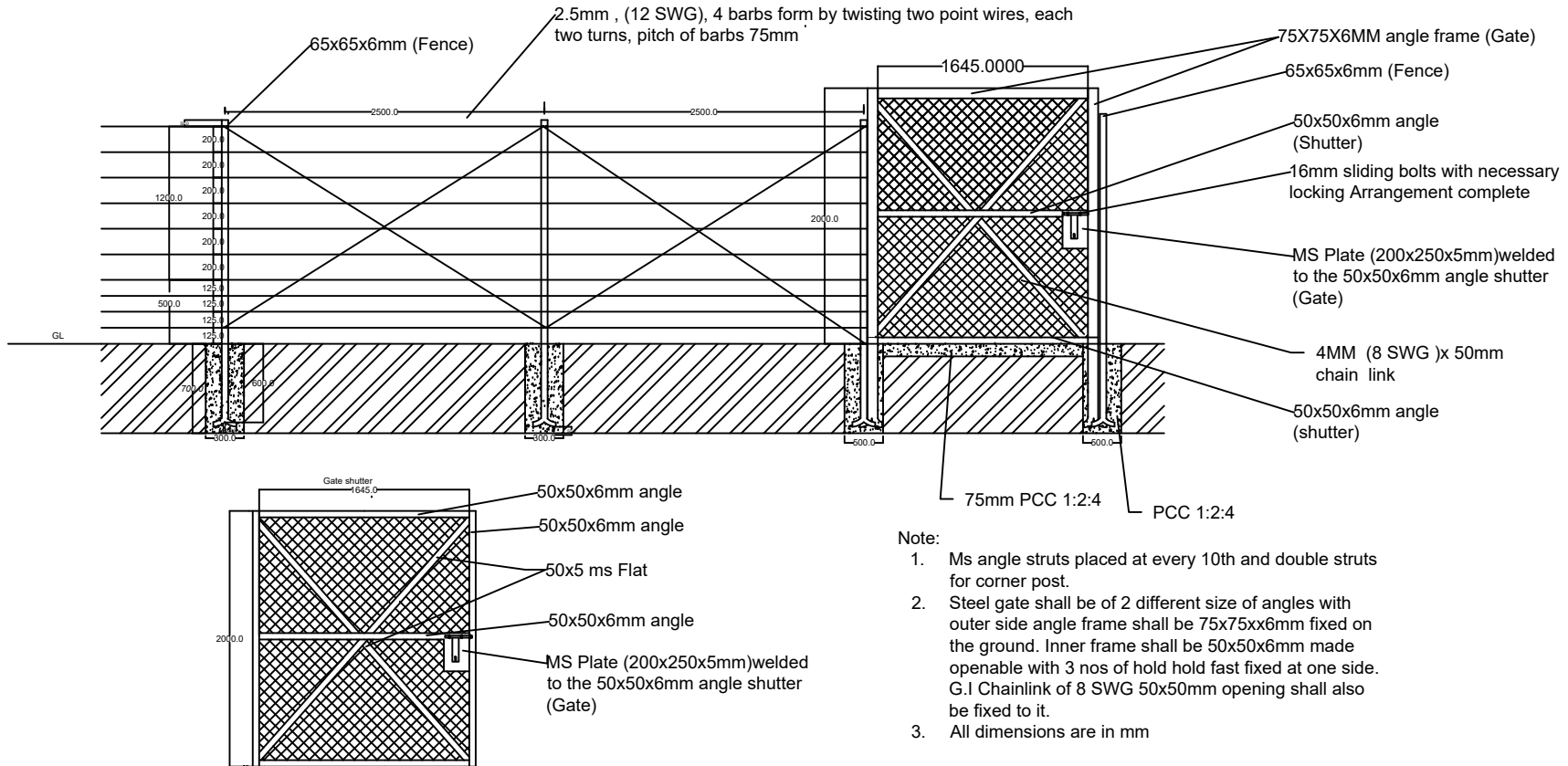

Title : Barbed wire fencing

BHUTAN TELECOM LIMITED

Checked by:

Approved by:

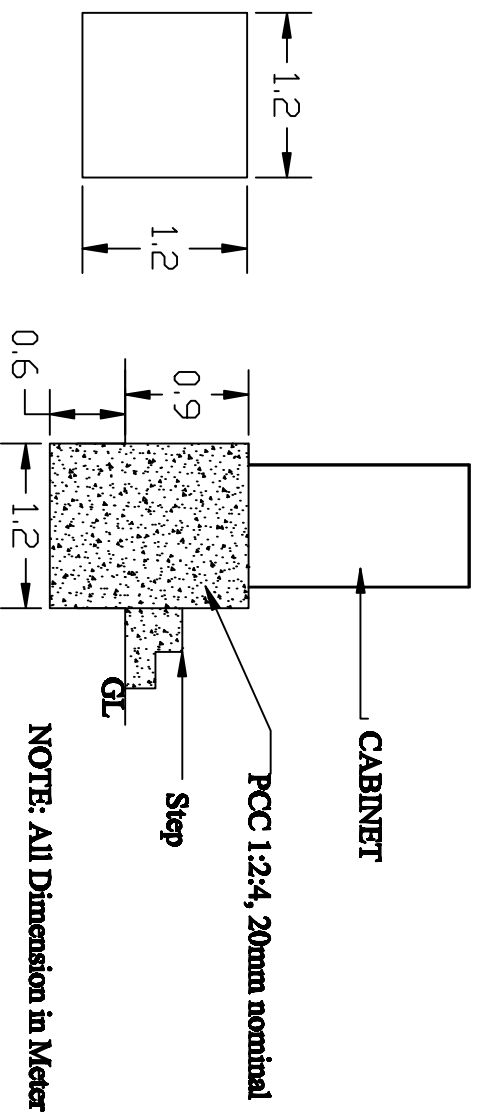

**CABINET STAND FOR HIGH ALTITUDE**